

Three-wheeled mobile platform powered by LabVIEW at energy performance index

Krzysztof Kaliński, Cezary Buchholz

Gdańsk University of Technology

Abstract: Outstanding growth in demand both of mobile platform operability performance and efficiency of project development methodology encourage to apply modern algorithms and reliable engineering tools design. Latest research results confirm that the energy performance index algorithm [1, 2] applied into strongly non-linear mechatronic object developed by use of mechatronic techniques can guarantee sufficient motion control in the reduced time design process. In this paper the authors present three wheeled mobile platform research object developed and controlled with a use of the LabVIEW software environment. In order to boost mobile platform performance and handle its real time surveillance motion process the authors implemented the NI cRIO controller (dedicated Real Time hardware powered by LabVIEW). Mathematical complexity of on-line algorithm and sophisticated model description affected all the process design. Presented parallel design methodology approach supported by mechatronic techniques [3] (virtual prototyping, Hardware-In-the Loop Simulations and rapid prototyping on a target object) allowed authors to achieve the highest level of a mobile platform system optimisation and increased probability of the final concept success.

Keywords: mobile platform, LabVIEW, energy performance index, mechatronic technique, real time

1. Introduction

For mobile platforms operating in harsh environment, like terrain or extraterrestrial planets (e.g. Moon or Mars) and during demanding activities where not only human life is exposed to high risk or performance of process is limited but also precision, high effectiveness and sometimes long term availability are considered, continuous motion, high operability and low power consumption are the core design factors. Effective power management system with real time algorithms leads to reducing overall energy consumption, increases mobility performance and distributes wheels' speeds and moments in an optimal way [4, 5]. Increasing computation ability of processors, parallel processing architectures, FPGA (Field Programmable Gate Array) usage and accurate sensors providing the opportunity for improvement of control performance, reduce faults of tolerance and simplify implementation of complex hardware and software design. However, inadequate design cannot withstand environmental conditions and acquire precise motion control. Moreover, not optimized control system causes dissipation of energy for unnecessary CPU computations and heat losses. Therefore the contemporary modern design process should be based on mechatronic attitude in understanding the effects of dynamic model of the platform and supported by comprehensive mechatronic development environment giving the possibility to prototype, design, simulate and integrate with dedica-

ted hardware. This paper discusses the mechatronic techniques (Virtual Prototyping, Hardware-In-the-Loop Simulations and Rapid Prototyping on the target object) supported by LabVIEW used during the design of the surveillance system based on energy performance index. Proposed control algorithm was implemented into Real Time controller cRIO-9076 powered also by LabVIEW and finally integrated with mobile platform (built for experimental purposes). Presented research object allowed authors to verify responses (for optimal control commands generated by Real Time controller) of the mobile platform while moving on three different trajectories (here the sine one is presented). This paper is organised as follows. General platform model and control algorithm are treated in section 2. Section 3 presents mechatronic techniques used during the research. In addition, partial experimental results are depicted. The mobile platform is presented in section 4. Conclusions are given in section 5.

2. Mobile platform model. Control algorithm approach

For research reasons, mathematical model of the mobile platform had to be established. An assumed model taken into consideration is presented in fig. 1. Mobile platform is composed of following main parts: chassis 5, driving system ZN and control system ZK. The driving system consists of two wheels 1 and 2, which thanks to differential mechanism are driven by one electrical motor 4. Wheels rotate about their axes, whose positions are invariable in relation to the frame. Components of the control system are: wheel 3 embedded in steering wheel 6, which is driven by the other electrical motor 4.

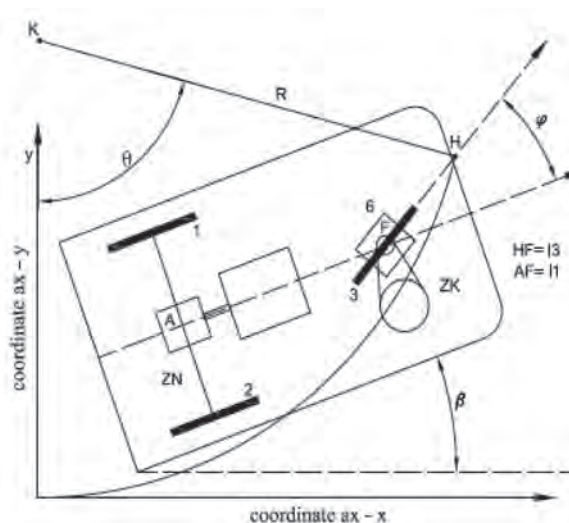

Fig. 1. Three-wheeled mobile platform model

Rys. 1. Model platformy mobilnej

Coordinates α_1 , α_2 and α_3 are the rotational angles of three mobile platform wheels 1, 2 and 3 respectively. The angle of steering wheel is denoted by φ . Angle β is the rotational angle displacement between the robot frame and fixed coordinate axis x . Point H belongs to control system. Angle θ defines rotation of a mobile platform on a circular trajectory. Point A is a point of intersection of the frame longitudinal symmetry axis with the axis of rotation of wheels 1 and 2.

Dynamics of controlled nonlinear mobile platform can be described as [1]:

$$\mathbf{M}^* \ddot{\mathbf{q}}^* + \mathbf{L}^* \dot{\mathbf{q}}^* + \mathbf{K}^* \mathbf{q}^* = \mathbf{f}^* + \mathbf{B}_u^* \mathbf{u}, \quad (1)$$

where signs \mathbf{M}^* , \mathbf{L}^* , \mathbf{K}^* , \mathbf{B}^* , \mathbf{q}^* , \mathbf{f}^* and \mathbf{u} denote respectively matrices of inertia, damping, stiffness and control, and also vectors of generalised displacements, forces and control commands of the system. Assuming that mobile platform moves on the flat surface, and considering changing with time kinetic energy of the system relatively to trajectory of given motion and $\delta \mathbf{u} \neq \mathbf{0}$, an optimal control command, for sampling time Δt , can be formulated [1]:

$$\mathbf{u}(t) = (\mathbf{R} + \mathbf{R}^T)^{-1} \int_{t-\Delta t}^t \mathbf{B}^T(\tau) \Theta^T(t, \tau) d\tau \cdot \mathbf{T}^T (\mathbf{Q}\mathbf{M} + \mathbf{M}^T \mathbf{Q}^T) (\dot{\mathbf{q}} - \dot{\bar{\mathbf{q}}}). \quad (2)$$

Defined control command $\mathbf{u}(t)$ for the mobile platform at time instant t , is calculated on a basis of matrices \mathbf{M} and \mathbf{L} , whose values are generated for time instant $t-\Delta t$.

Representing a step of integration Δt is limited by CPU performance of applied mobile platform controller (here is National Instruments cRIO-9076, 400 MHz, powered by LabVIEW) and has considerable impact on situation where any control command is generated. A lack of control signal (during time period Δt) can cause significant deviations between actual and desired trajectory of the platform, and thus disturbs energy system balance. Authors followed by the research goals wanted to build system with minimal energy losses (error minimization). Common approach encourages decreasing to minimum time Δt (mainly by speed up CPU clock frequency) and find minimal error level. In this study limitations of applied controller had to be considered. Fixed CPU clock and willingness to keep application's real time determinism forced authors to find balance between time Δt and error level occurrence.

During the study authors investigated remedies for described system balance and defined suitable correction velocities and implemented them into the optimal control command $\mathbf{u}(t)$. Defined correction velocities can be given as:

$$\dot{x}_H = \frac{\bar{x}_H - x_H}{k\Delta t}; \quad \dot{y}_H = \frac{\bar{y}_H - y_H}{k\Delta t}. \quad (3)$$

where: \bar{x}_H and \bar{y}_H – Cartesian coordinates describing desired position of characteristic point H of the platform in time t ; x_H and y_H – Cartesian coordinates

describing actual position of characteristic point H of the platform in time t ; k – coefficient determined in a way of simulation [6]. Bearing in mind defined correction velocities, vector of correction velocities $\dot{\mathbf{q}}$ can be calculated and optimal control command (eq. 2) can be modified as follows:

$$\mathbf{u}(t) = (\mathbf{R} + \mathbf{R}^T)^{-1} \int_{t-\Delta t}^t \mathbf{B}^T(\tau) \Theta^T(t, \tau) d\tau \cdot \mathbf{T}^T (\mathbf{Q}\mathbf{M} + \mathbf{M}^T \mathbf{Q}^T) (\dot{\mathbf{q}} - \dot{\bar{\mathbf{q}}}). \quad (4)$$

where: \mathbf{Q} – dimensionless matrix of influence of kinetic energy, \mathbf{R} – matrix of the control command's effect, $\dot{\mathbf{q}}$, $\dot{\bar{\mathbf{q}}}$, $\dot{\mathbf{q}}$ – vectors of actual generalised velocities, generalized velocities in the desired motion, and correction velocities. For time Δt , where the time determinism is hold, applied correction velocities can lead to elimination of the mobile platform error occurrence and improve considerably system energy efficiency.

In considered research by use of presented in section 3 of this paper mechatronic techniques, optimal signal generation time Δt was established. During the virtual prototyping technique (first stage of this study) authors adjusted Δt for 0.001 s, but demanding computation process of on-line algorithm and real time conditions (equalization between simulation and real time clock readings) of the HILS tests verified previous assumptions and final Δt was set for 0.005 s. Having ability to use FPGA (integral part of applied controller), authors decided to allocate there certain parts of the algorithm code (responsible for PWM formation). By this move considerable increase of controller output level (decreasing of CPU and memory usage) was obtained.

3. Mechatronic techniques. Design methodology supported by LabVIEW

Latest tendency in mechatronic design requires the use of comprehensive development environment giving the possibility to prototype, design, simulate and integrate with dedicated hardware. Similar concept was used to design and develop surveillance system for three wheeled mobile platform.

In order to have a system which reflects research needs, the mobile platform was also, first designed and afterwards created.

Design methodology used during the research was presented in fig. 2.

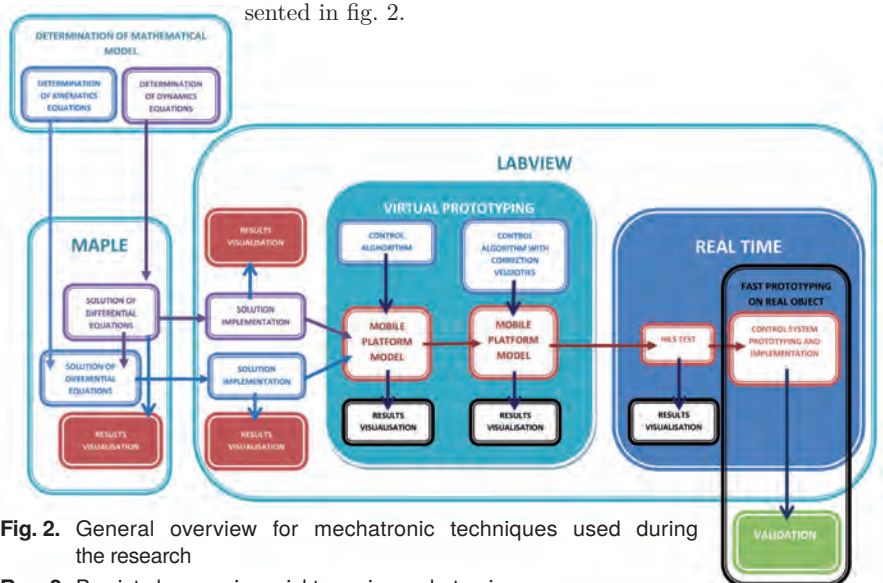

Fig. 2. General overview for mechatronic techniques used during the research

Rys. 2. Przyjęta koncepcja projektowania mechatronicznego

Techniques of Virtual prototyping, HILS and finally – rapid prototyping on real target object, were used to assist researchers to complete development process of complex mobile platform surveillance system and achieve (by optimisation of algorithm, configuration, control strategy) highest performance integration with the mobile platform design.

3.1. Virtual prototyping

Modern machines developed to withstand critical operation, but also contemporary ordinary mechatronic devices or customer demands are facing growing challenges. These include verifying more complex mechanical design, hardware and software in a timely and cost effective manner. It also requires to communicate efficiently their specification across design methodology. Virtual prototyping is a technique where authors by creation of virtual model of the mobile platform (differential equations of the mobile platform were computed symbolically in the Maple software; parametrical solutions were implemented into LabVIEW) were able in shortened time to verify responses (on PC) for optimal signals generated by proposed algorithm (virtually implemented into LabVIEW software). General overview of applied technique was shown on fig. 3.

During this stage of study (virtual prototyping), it was necessary, firstly to guaranty correctness of algorithm implementation (into the LabVIEW) and secondly (in parallel) to achieve optimisation both in controller architecture and model of the mobile platform (by establishing boundary conditions for the final design).

Optimal control signals (torques), defined by eq. 4 were shown in fig. 4 and fig. 5 (for the sine trajectory). In order to verify implementation process of controller and adjust properly coefficients of **R** and **Q** matrices (of algorithm) desired solutions (of Langrage equations solved during virtual simulation) together with optimal signals were generated. Similar process was applied for model optimisation, where authors by comparing parameters of the mobile platform kinematics with desired values (generated in the same time) were able to finalize the model design. Responses for the sine trajectory were presented in fig. 6, fig. 7 and fig. 8. It is seen that virtual platform moves on proper trajectories with small error whose occurrence can be explained by high nonlinearity of the model design and applied numerical computation process. With a use of virtual prototyping technique authors in shortened time period achieved desired implementation of the energy performance index and were allowed to conduct complex optimisation process of the controller software architecture (software debugging, pre-adjusting matrices **R** and **Q**). Additionally, numerous values of the mobile platform parameters were verified.

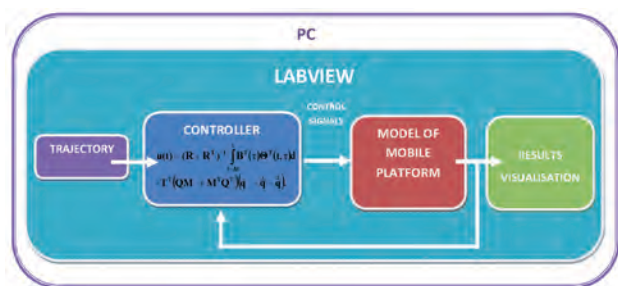

Fig. 3. Virtual prototyping concept
Rys. 3. Koncepcja wirtualnego prototypowania

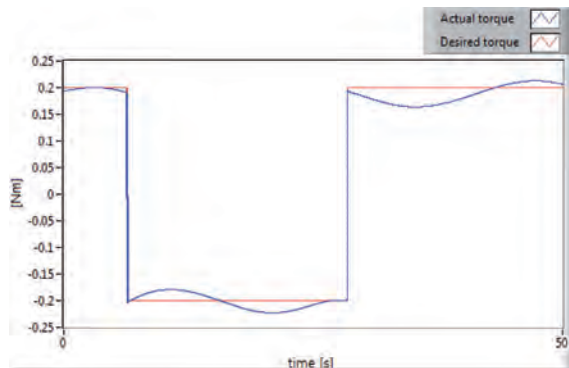

Fig. 4. Steering wheel torque
Rys. 4. Moment kierujący

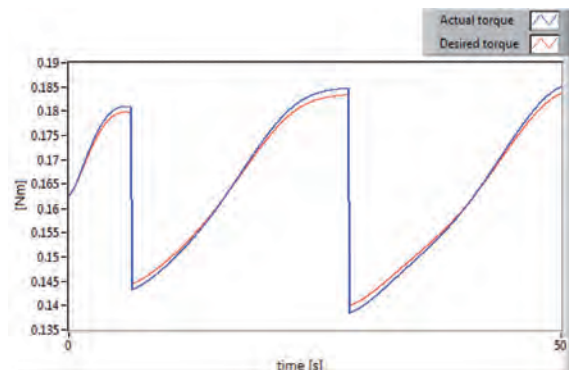

Fig. 5. Propulsion torque
Rys. 5. Moment napędowy

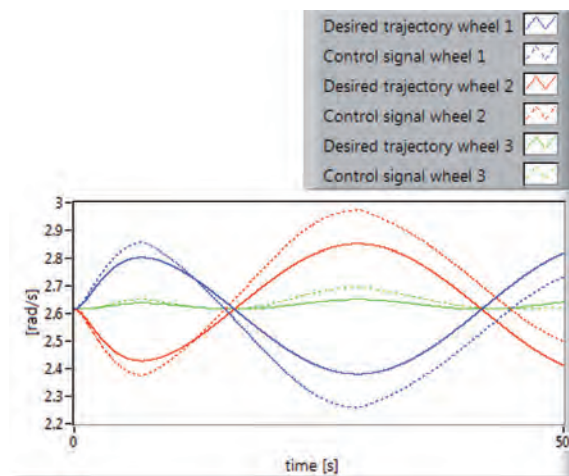

Fig. 6. Wheel speeds (virtual prototyping)
Rys. 6. Prędkości kątowe poszczególnych kół

3.2. HILS

The concept of the HILS technique has been recognized as effective method for prototyping and design. Authors by the use of the Real Time LabVIEW module performed deterministic test configuration where in synchronism both emulated mobile platform (virtual model created during previous stages of the research) and the real control system (here controller NI cRIO-9076) were tested.

In the presented study the HILS technique with its low cost and flexibility was used to assist researchers to complete development process of complex mobile platform surveillance

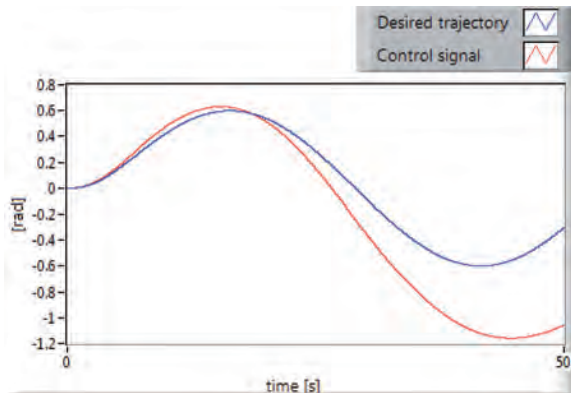

Fig. 7. Frame angle (virtual prototyping)

Rys. 7. Chwilowa wartość kąta obrotu platformy

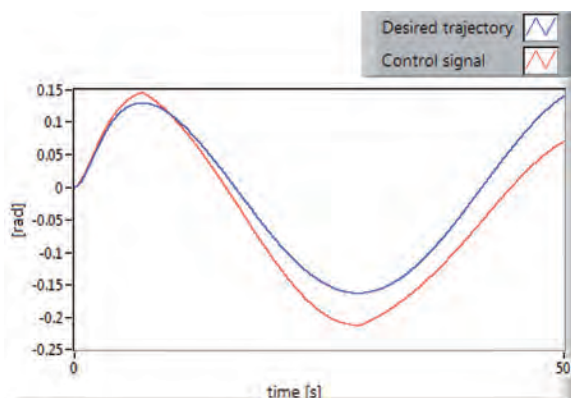

Fig. 8. Steering wheel angle (virtual prototyping)

Rys. 8. Chwilowa wartość kąta obrotu kierownicy

system and achieved (by optimisation of algorithm, configuration, control strategy) highest performance of the design. Experimental setup was presented in fig. 9, where in real time tests the researchers verified response of emulated mobile platform model for control signals (torques) generated by real time controller (where designed algorithm was executed). The authors demonstrated in fig. 10 suitable block diagram where real time controller generates torques signals (i.e. M1, M2 – specific for each trajectory) which via IP network (buffered real time variables were used) are sent to the emulated mobile platform. Based on received torques (M1, M2), in real time process (PC with installed LabVIEW Real Time module) forward dynamic and forward kinematic equations are resolved. The test was performed for three different mobile platform trajectories: circular, parabolic and sinusoidal (the sinusoidal one is presented in this paper). The desi-

gned algorithm (eq. 4) implemented into the NI-9076 controller generated in real time for each (defined) trajectory optimal signals (torques). Responses (also in real time) by use of experimental adjustment of matrices **R** and **Q** were verified. Control signals (the same as during virtual prototyping) and responses were shown in fig. 11, fig. 12 and fig. 13 respectively. As it was done before, in order to perform verification process correctly, the reference (desired) value for each response was drawn.

Due to the specific setup of the performed test, where virtual model of the research object is investigated (emulated three wheeled mobile platform) differences between responses obtained by the HILS technique and desired values can be seen (virtual simulation). The authors' research experience taken from this study suggests several aspects which should be considered in the final test evaluations. Considerable meaning in the HILS test results has mathematical model of the research. High non-linearity of the model (mainly inertia matrix) affects difficulties in control stability (matrix coefficients addicted to steering wheel angle). Additionally sophisticated computational process of differential equations impacts on numerical errors occurrence. Despite existed differences the test purpose was achieved. By fulfilling time determinism requirement a sufficient integration time was applied and system energy balance on this stage of study was obtained. Modification of code algorithm execution, where authors decided to split the process for two controller locations: one executed in real time processor and the other executed in the FPGA increased final system performance.

Conducted specific methodology in a surveillance system design resulted possibility of testing different system configurations during different operation conditions avoiding unnecessary damage and without having to build. Occurring similarities in model responses acknowledged that surveillance system was designed correctly with optimal energy configuration efficiency and the success of final integration with real mobile platform can be expected.

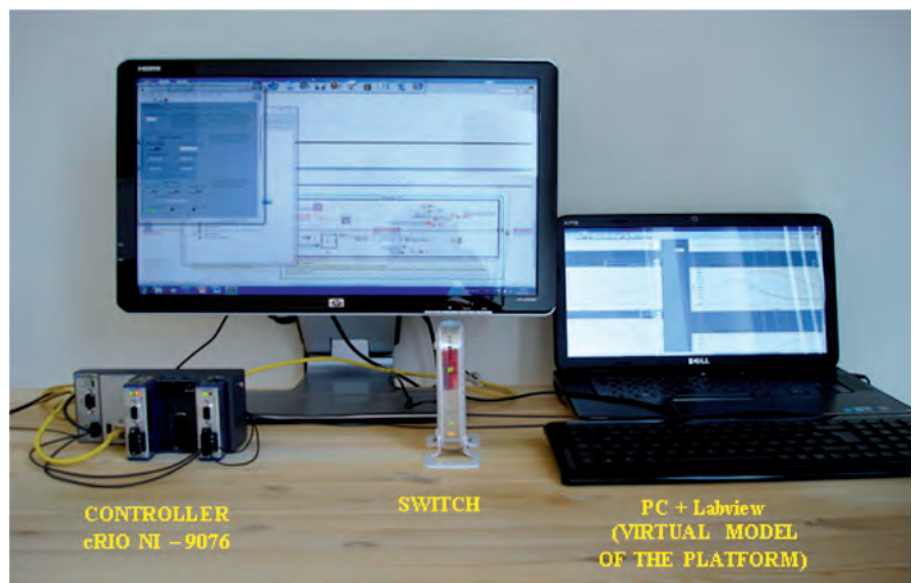

Fig. 9. Experimental setup of the HILS test

Rys. 9. Stanowisko pomiarowe w technice HILS

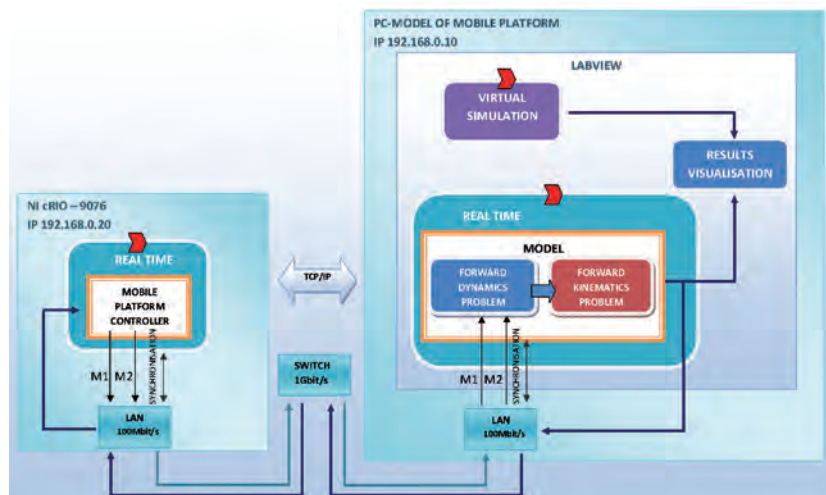

Fig. 10. Block diagram of the HILS test

Rys. 10. Schemat blokowy w technice HILS

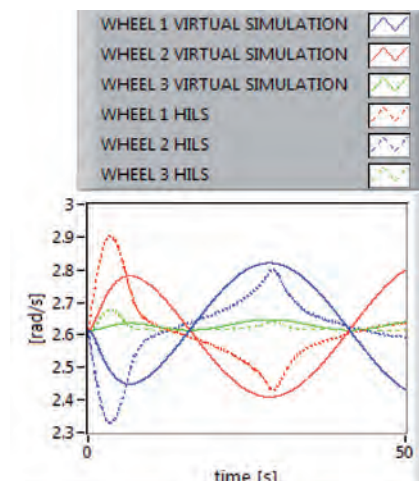

Fig. 11. Wheel speeds (HILS)

Rys. 11. Prędkości kątowne poszczególnych kół

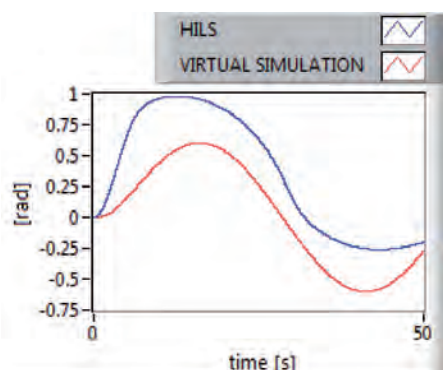

Fig. 12. Frame angle (HILS)

Rys. 12. Chwilowa wartość kąta obrotu platformy

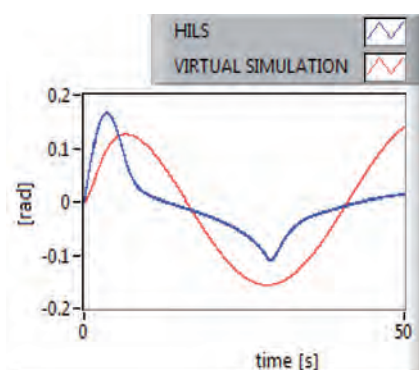

Fig. 13. Steering wheel angle (HILS)

Rys. 13. Chwilowa wartość kąta obrotu kierownicy

2. Mobile platform validation while moving on desired trajectories (verification of algorithm performance). 3. Algorithm debugging and control system adjustments (the R and Q matrices, PWM). Checking procedure of algorithm performance was executed by measuring deviation between real position

3.3. Rapid prototyping on a real target object

Very often, when the system or the object exists and in the same time there is still a need to implement new (machine or one of the part will be automated) or upgrade the old control system (new functionality was introduced) rapid prototyping on real (existing) object is frequently used. In classical approach, machine controller is prototyped on high advance real time hardware (i.e. cLogic card) where, by support of dedicated development software environment, control algorithm can be designed and on the fly compiled. During previous (applied in this study) mechatronic techniques the optimal architecture of surveillance system was worked out and designed mobile platform was built. As it was mentioned before the authors decided to use the cRIO controller as a hardware platform for control motion of the mobile robot. Existing both object and control hardware encouraged authors to modify current survey (technique) and connect prototyping process with the final implementation (and validation). A concept of the prototyping test setup configuration was show in fig. 14. Considering (iteration) development process was organized as follows: 1. Algorithm compilation and deployment to controller (Real Time and FPGA).

of the platform and point 0 of the Cartesian coordinate system Oxy located on desired trajectory. For every trajectory the authors established several places where the measurements were taken. The sine test trajectory with check points is presented in fig. 15. The authors in fig. 16 (left) demonstrated result for the last point of the trajectory taken when the mobile platform moved with 0.17 m/s. Fig. 16 (right) presents results for the same check point but speed of the platform was set for 0.31 m/s (90 % of max. speed). It is necessary to state that preliminary assumptions suggested that mobile platform would be moving with 0.17 m/s, but surprisingly during the commissioning of the system maximal speed was verified to 0.35 m/s. Significant discrepancy is explained by better power efficiency of the DC propulsion engine that it was anticipated and lower gear in the differential system as it was given by part distributor. The test results for both applied speeds confirm sufficiently good performance of proposed method to control strongly nonlinear object. During the test the mobile platform reached the final destination with demanding repeatability. Small error occurrence can be avoidable by comparison with the complexity of the trajectory, the distance to travel and the size of object. Numerical errors should be also considered.

4. Three wheeled mobile platform powered by LabVIEW

A concept of the object mechanical construction appeared in early phase of the research and as it was presented in fig. 2, the main idea was to base propulsion system on differential gear connected centrally to electrical motor (Micromotors). Development process performed together (in number of iterations and feedbacks) with surveillance systems design affected to build mobile platform whose final form (used during experiment) was depicted in fig. 17 (left) (front-side view) and fig. 17 (right) (bottom view). The electrical line scheme was shown in fig. 18. The main component of the presented system was based on cRIO NI-9076 controller powered by LabVIEW, where the proposed algorithm is computed. Modules NI-9505 play significant role in DC

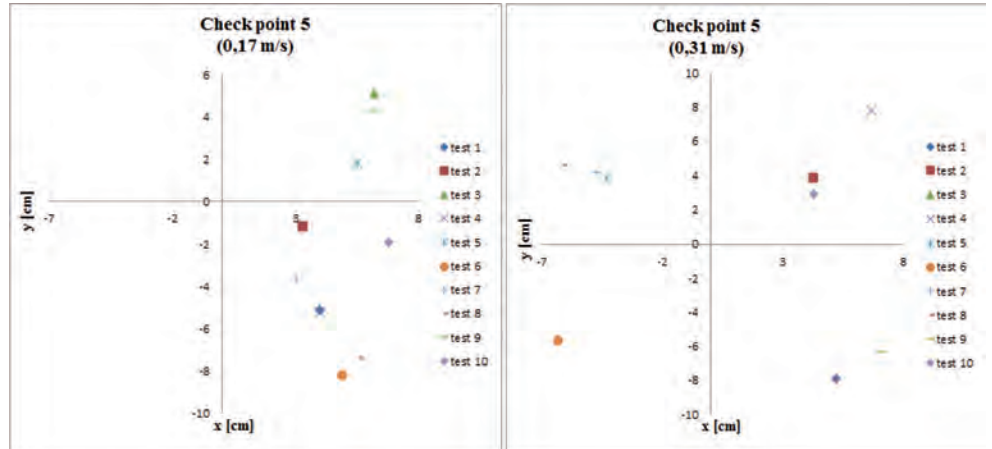

Fig. 16. Experimental results
 Rys. 16. Rezultaty przeprowadzonych doświadczeń

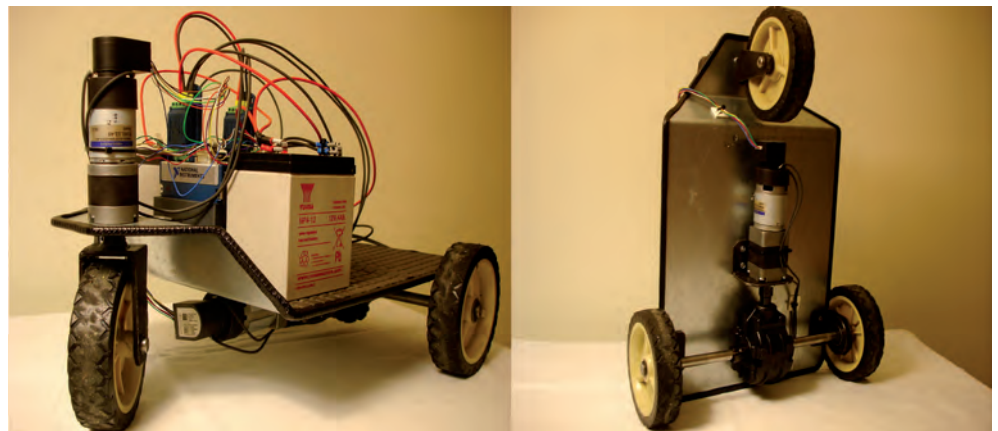

Fig. 17. Three wheeled mobile platform
 Rys. 17. Trójkołowa platforma mobilna

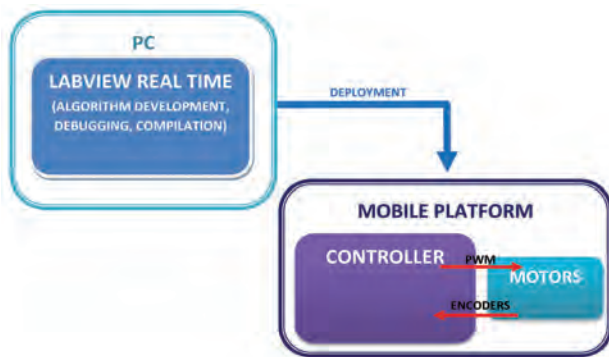

Fig. 14. Block diagram of rapid prototyping on target object
 Rys. 14. Schemat blokowy techniki szybkiego prototypowania na obiekcie docelowym

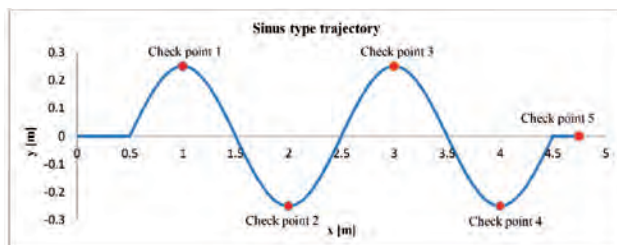

Fig. 15. Test trajectory for mobile platform
 Rys. 15. Trajektoria typu sinus

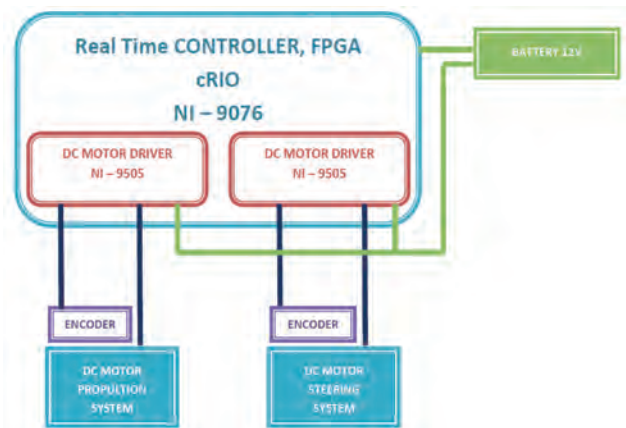

Fig. 18. Mobile platform electrical scheme
 Rys. 18. Schemat układu elektrycznego

motor control (PWM generation) and give the interface to optical encoders with high resolution (1000 impulses per motor rotation). Optimised level of signal generation frequency forced authors to apply only such solutions which parameters or its characteristics would not influence time system response (i.e. 0.005 s). The cRIO controller concept by high-end and flexible architecture allows to develop deterministic application both in real time processor and FPGA. Authors used this convenience and by splitting algorithm for two parts (as it was mentioned above) afterwards deployed them one by one to dedicated controller location.

5. Conclusion

The presented research study in this paper, supported by LabVIEW, allowed by use of mechatronic techniques to develop mobile platform surveillance system and implemented into real time controller (powered by the same software environment).

Validation in conjunction with rapid prototyping on real object confirmed in experimental way, that proposed energy performance index can be widely used to control nonlinear systems.

Tested with success mobile platform trajectory variants and movement speeds guarantee algorithm flexibility in future implementations.

The authors, in order to reduce the project cost, applied the HILS technique to design system with the highest controller performance and energy optimisation. In addition, significant reduction of time verification and extended test possibility of the other design variants were achieved.

Bibliography

1. Kaliński K., *Nadzorowanie drgań układów mechanicznych modelowanych dyskretnie*, Wyd. Pol. Gdańskiej, 2001, 28–35.
2. Galewski M, Kaliński K., *Nadzorowanie drgań przy frezowaniu szybkościowym smukłymi narzędziami ze zmienną prędkością obrotową*, Wyd. Pol. Gdańskiej, 2009, 59–63.
3. Petko M., *Wybrane metody projektowania mechatronicznego*, Instytut Technologii Eksploatacji – PIB, 2008, 15–36.
4. Kaliński K., Buchholz C., *Trajectory optimal control of three wheeled mobile platform at time changeable energy performance index*, 10th Conference Active Noise and vibration control methods, 2011, Cracow, Poland.
5. Kaliński K., Buchholz C., *Error minimisation in orientation and localization by correction velocities for three-wheeled mobile platform at time changeable energy performance index*, 16th International Conference on Methods and Models in Automation and Robotics, 2011, Międzyzdroje, Poland.
6. Kaliński K., Buchholz C., *Mobile platform power optimisation by control command at time changeable energy performance index*, Annual International Workshop 2011 – Dynamic Behaviour of Structures and Materials, Interaction and Friction, 2011, Metz, France. ■

Środowisko LabVIEW w projektowaniu mechatronicznym trójkołowej platformy mobilnej przy energetycznym wskaźniku jakości

Streszczenie: Rosnące wymagania stawiane platformom mobilnym, w zakresie wysokiej operacyjności oraz sprawności energetycznej, skłaniają do stosowania wydajnych algorytmów sterowania ich ruchem, a także efektywnych środowisk projektowania mechatronicznego. Badania autorów są dowodem skuteczności sterowania optymalnego przy energetycznym wskaźniku jakości [1, 2], jako trafnej metody w zastosowaniu do obiektów silnie nieliniowych. Zaimplementowany do systemu sterowania algorytm, którego koncepcja bazuje na rozpatrywanym wskaźniku jakości, zagwarantował przejazd platformy po wytypowanych trajektoriach z oczekiwaną dokładnością. W artykule opisano koncepcję trójkołowej platformy mobilnej, powstałą jako efekt zastosowania wybranych technik projektowania mechatronicznego, czyli [3] wirtualnego prototypowania, HILS (Hardware-In-the-Loop Simulations) oraz szybkiego prototypowania na obiekcie docelowym. Wraz z systemem sterowania bazowało ono na zintegrowanym środowisku LabVIEW. Złożoność matematyczna zastosowanego algorytmu on-line oraz modelu obliczeniowego platformy, a także konieczność sterowania obiektem w czasie rzeczywistym, wymagały użycia dedykowanego sterownika platformy. Wybór jednostki National Instruments cRIO, wraz z zastosowanymi technikami projektowania mechatronicznego, pozwoliły autorom osiągnąć zakładaną skuteczność sterowania platformą mobilną, przy jednoczesnym spełnieniu warunku optymalizacji energetycznej systemu, a także ograniczyć znacząco czas realizacji projektu platformy.

Słowa kluczowe: platforma mobilna, LabVIEW, energetyczny wskaźnik jakości, mechatronika, czas rzeczywisty

Professor Krzysztof Kaliński, PhD

He is professor in applied mechanics and mechatronics, Faculty of Mechanical Engineering, Gdańsk University of Technology. He developed his expertise and experience in scope of machine dynamics, robotics, vibration engineering and high speed machining. His research interests concern mechatronic design, dynamics and optimal control, as well as structural and strength analysis.

e-mail: kkalinsk@o2.pl



Cezary Buchholz, MSc

He performs his PhD theses in Faculty of Mechanical Engineering, Gdansk University of Technology. He received his MSc in Faculty of Electronics and Telecommunications and Informatics, Gdańsk University of Technology. He maintains a wide interest in many areas of mechatronics and electronics especially focused on real systems, LabVIEW programming and power electronics.

e-mail: cezary.buchholz@gmail.com

